

Dell™ XPS 18
User's Manual



Notes, Cautions, and Warnings



NOTE: A NOTE indicates important information that helps you make better use of your computer.



CAUTION: A CAUTION indicates potential damage to hardware or loss of data if instructions are not followed.



WARNING: A WARNING indicates a potential for property damage, personal injury, or death.

Information in this document is subject to change without notice.

© 2013 Dell Inc. All rights reserved.

Reproduction of these materials in any manner whatsoever without the written permission of Dell Inc. is strictly forbidden.

Trademarks used in this text: Dell™ the DELL logo, and XPS are trademarks of Dell Inc.; Microsoft®, and Windows® are either trademarks or registered trademarks of Microsoft Corporation in the United States and/or other countries.

Other trademarks and trade names may be used in this document to refer to either the entities claiming the marks and names or their products.

Dell Inc. disclaims any proprietary interest in trademarks and trade names other than its own.

Contents

1	Features	6
2	Accessories	10
3	Setting Up Your Computer	12
	Connect the Power Cable to the Power Adapter	12
	Charge Your Computer	13
	Insert an SD Card (optional)	15
	Turning On Your Computer	16
	Enable/Disable Wi-Fi	18
	Connecting to a Network	18
	Switch Networks	18
4	Using Your Computer	19
	Screen Orientation	19
	Windows 8 Start Screen	20
	Gestures	21
	Using Headphones/Microphones	26
	Removing the SD Card	27
	Turning Off the Screen	28
	Turning Off Your Computer	28
	Managing Computer Settings	29
5	Synchronizing Your Computer	31

6	Powered Stand (optional)	32
	Features	32
	Using the Powered Stand	34
	Dock Your Computer on the Powered Stand.	36
	Undocking Your Computer	37
7	Cleaning Your Computer	38
8	Troubleshooting.	39
9	Locating Your Service Tag and Express Service Code	43
10	Specifications	44

Features

This section provides information about the features available on your computer.

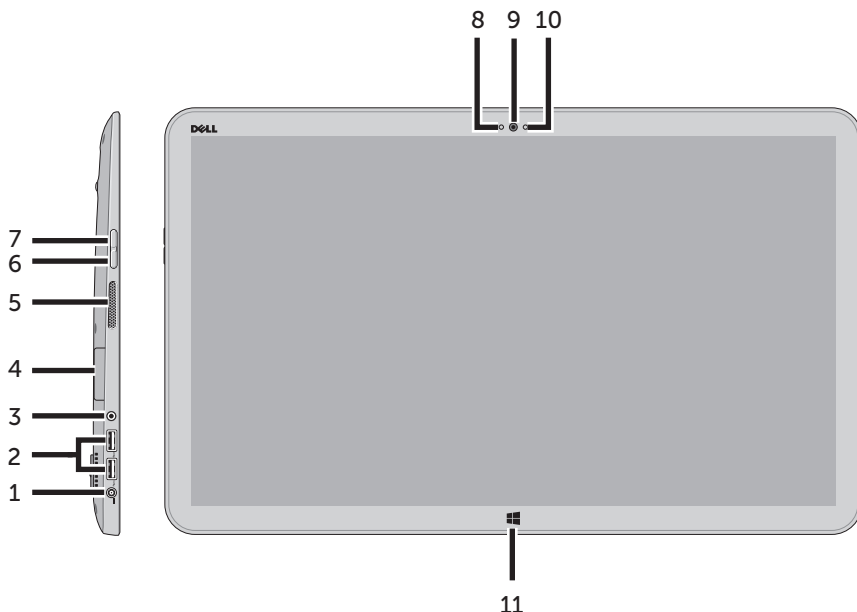

Feature	Functionality
1 Power-adapter port	Connect the supplied power adapter to provide power to the computer and charge the battery.
2 USB 3.0 ports (2)	Connect USB devices for transferring or synchronizing data, music, photos, videos, contacts, and so on.
3 Audio port (3.5 mm)	Connect headphones, microphones, and other audio equipment to listen to stereo sound, record audio, or make calls.
4 SD-card slot	Full-sized SD-card slot.
5 Left speaker	Provides audio output for video and music playback.

Feature	Functionality
6 Volume-down button	<ul style="list-style-type: none">• Press to decrease the volume by one level.• Press and hold to continuously decrease the volume.
7 Volume-up button	<ul style="list-style-type: none">• Press to increase the volume by one level.• Press and hold to continuously increase the volume.
8 Camera-status light	Turns on when camera is active.
9 Front-facing camera	<ul style="list-style-type: none">• Capture a front-view picture or record videos.• Make video calls with web applications, such as Skype.
10 Ambient-light sensor	Automatically adjusts the brightness of the display's backlight based on surrounding light levels.
11 Windows button	<ul style="list-style-type: none">• Press to access/show the Windows Start screen.• Press for quick access to the most recently used application or most recently viewed screen.

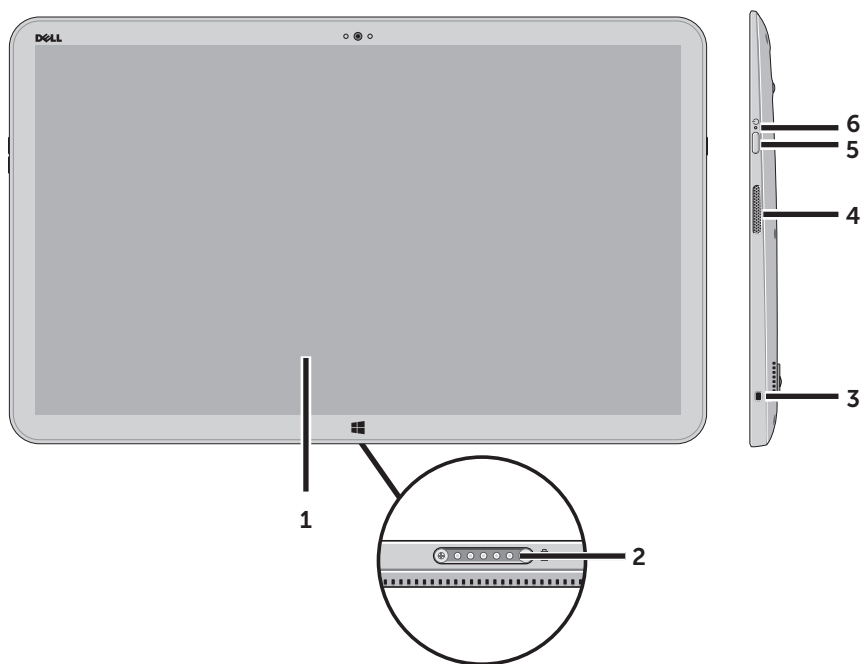

Feature	Functionality
1 Touchscreen display	Touch the display to use on-screen controls including buttons, menu items, and the on-screen keyboard.
2 Docking port	Connect to a Dell Powered Stand (optional).
3 Noble lock port	Allows you to secure your computer using a Noble lock.
4 Right speaker	Provides audio output for video and music playback.
5 Power and sleep/wake button	Press and release to turn your computer on or off.
6 Power/Battery-status indicator	Indicates the power/battery charge status. (see battery status table)

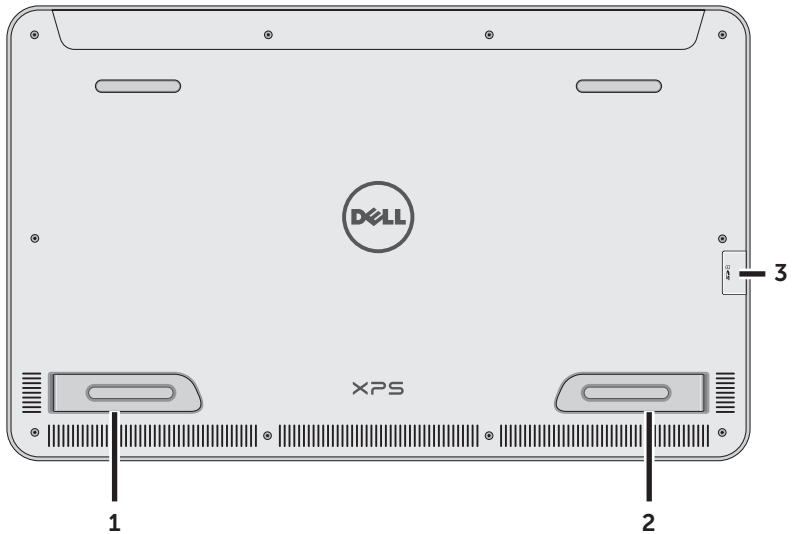

Feature	Functionality
1 Right foot CAUTION: Not for use in portrait mode	Fold outwards to allow your computer to stand upright, fold inwards to allow your computer to lay flat.
2 Left foot CAUTION: Not for use in portrait mode	Fold outwards to allow your computer to stand upright, fold inwards to allow your computer to lay flat.
3 SD-card slot	Full-sized SD-card slot.

Accessories

Your computer package includes the following accessories:

- **Power adapter and cable** — Provides power to your computer and charges the battery.



- **USB to ethernet adapter (optional)** — Allows you to connect a RJ45 (network) cable to your computer using a USB port.



- **Powered stand (optional)** — Allows your computer to be placed upright with adjustable viewing angles and battery charging capabilities.



- **Wireless keyboard and mouse (optional)** - Inputs text and controls the cursor.



 **NOTE:** The keyboard and mouse are already paired to your computer if you ordered the keyboard and mouse along with your computer. If you purchased the keyboard and mouse separately, or if you need to pair them again, see [Pairing the Wireless Keyboard and Mouse](#).

Setting Up Your Computer

This section provides information about setting up your computer for first use.





WARNING: Before you begin any of the procedures in this section, read the safety information that shipped with your computer. For additional best practices information, see www.dell.com/regulatory_compliance.

Connect the Power Cable to the Power Adapter



Charge Your Computer

 **CAUTION:** Charge the battery in an environmental temperature between 0 °C and 40 °C (32 °F and 104 °F).

 **CAUTION:** Use only the supplied power adapter and power cable to charge your computer. Using unauthorized power adapters or power cables may severely damage to your computer.

 **NOTE:** Your computer *cannot* be charged through a USB cable.

 **NOTE:** The battery is not fully charged when you first receive it.

 **NOTE:** You receive your computer in shipping mode to prevent it from accidentally turning on during shipping. To turn on your computer for the first time, connect the power adapter and then press the power button.

- 1 Connect the power adapter to your computer.

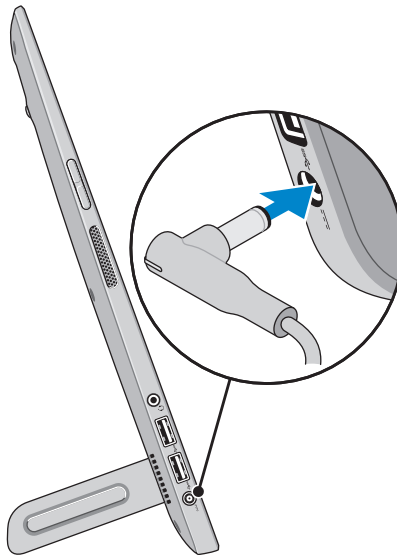

- 2 Connect the power adapter into an electrical outlet and charge your computer until the battery is fully charged.

 **NOTE:** A completely discharged battery takes 4-5 hours to charge fully while the computer is turned off.







 **NOTE:** The battery charge light on the right side of your computer turns off once the battery is fully charged.

You can check the charge/power status of your computer by checking the light on the side of your computer or the icon on the screen when your computer is turned on:

Battery-charge indicator located on the right side of your computer:

Power state	Battery with no power adapter	Power adapter and battery fully charged	Power adapter and battery is charging
S0/S1 (ON)	Solid white	Solid white	Solid amber
S3 (Sleep)	Slow blinking white	Slow blinking white	Slow blinking amber
S4/S5 (Hibernate or OFF)	OFF	OFF	Solid amber
Low battery	Fast blinking amber	Fast blinking amber	Fast blinking amber

Battery icon displayed on the screen:

Battery icon	Description
	Battery is fully charged
	Battery is charging
	Computer is running on battery power and the battery is discharging.
	Computer is plugged in, and either no battery is detected, or the battery isn't working correctly.
	Battery is low
	Battery is critically low

 **NOTE:** You can check exact battery charge level by booting to the operating system.

Insert an SD Card (optional)

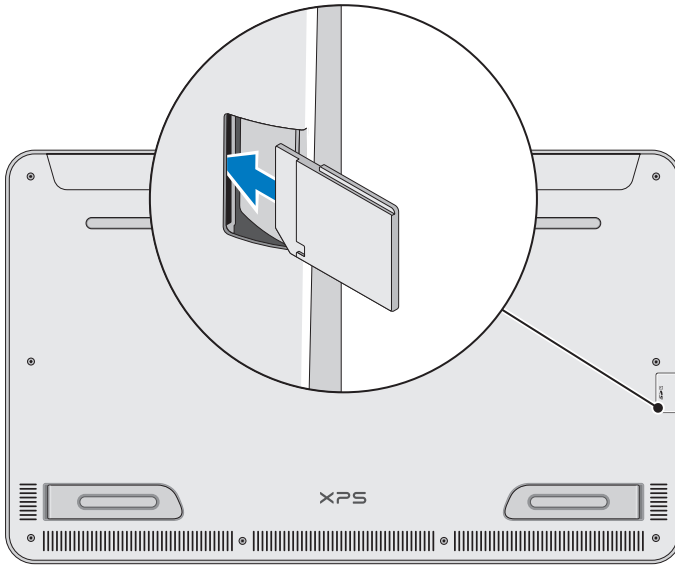

- 1 Make sure the orientation of the SD card is correct so that the pins on the card are facing the rear when inserted.
- 2 Push the slot cover down.
- 3 Push the SD card into the spring-loaded slot until it is locked firmly into place.



NOTE: The SD-card slot is compatible with Standard-Capacity (SDSC), High-Capacity (SDHC), the eXtended-Capacity (SDXC) storage cards, Memory Stick, Memory Stick Pro, MMC, and xD, with a maximum storage capacity of 2 TB.

Turning On Your Computer

 **CAUTION:** Use your computer in an ambient temperature between 0 °C and 35 °C (32 °F and 95 °F).

- 1 Press and release the **Power and Sleep/Wake** button .

 **NOTE:** After the button is pressed, there is a slight delay before your computer turns on or off.

- 2 Complete all steps for the initial setup of Windows including Personalize, Settings, Sign in.
- 3 Enable security on the Security & Dell Updates page.

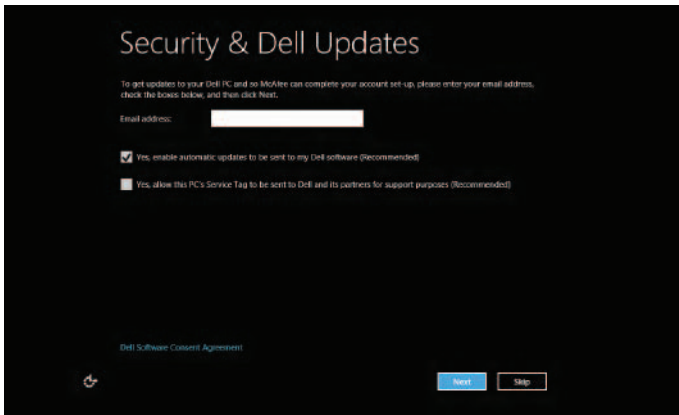

- 4 Configure wireless settings (optional).

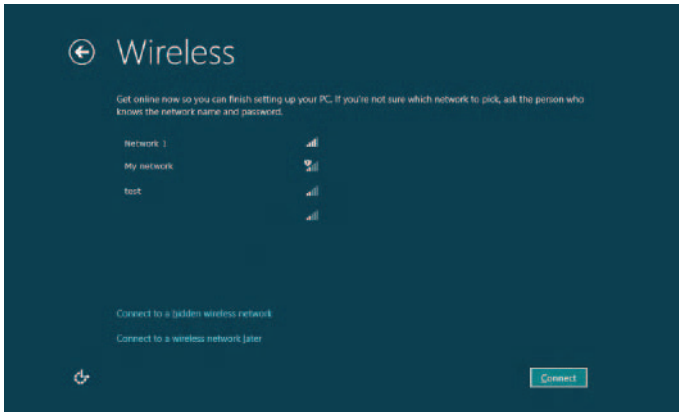

5 Complete initial setup of Windows.

Your computer is ready for use when the Windows Start screen is displayed.



NOTE: A lock screen may be displayed when your computer wakes up from a sleep state.





NOTE: If the login screen is not enabled, the Start screen appears after you swipe-up on the lock screen.

Enable/Disable Wi-Fi

- 1 Swipe from the right edge of the display to access Charms.
- 2 Touch **Settings**  → **Change PC settings** → **Wireless**.
- 3 Move the slider to the right to enable Wi-Fi. Move the Wi-Fi slider to the left to disable Wi-Fi.

Connecting to a Network

- 1 Swipe from the right edge of the display to access Charms.
- 2 Touch **Settings**  → **Available**  → Select an available network → **Connect**.

Switch Networks



NOTE: If you need to connect to another network later, access Charms →  and select the network you want to connect to.

Using Your Computer





Screen Orientation

For optimal viewing experience, the screen orientation changes automatically to portrait or landscape format depending on your computer's orientation. Automatic screen rotation is enabled by default.



NOTE: Some applications may not support automatic screen rotation.



Enabling/Disabling automatic screen rotation

- 1 Swipe from the right edge of the display to access Charms.
- 2 Touch **Settings**  → **Screen** .
- 3 Touch  or  to toggle automatic screen rotation.



Windows 8 Start Screen

The Windows 8 Start screen displays a list of default and custom Live Tiles, which act as shortcuts to various installed applications.

Live Tiles on your Start screen update in real time with information on news, sports, weather, stocks, social networks, and so on. The tile-based user interface gives you direct access to your most recently used applications, emails, photos, music, videos, contacts, social media updates, and frequently viewed websites. You can pin desired or favorite applications as Live Tiles to customize the Start screen.

 **NOTE:** You can add or remove Live Tiles by using Pin  or Unpin  options.

Accessing the Start screen

- Press the **Windows** button .
- Swipe from the right edge of the display to access Charms, and then touch the **Start** icon .

 **NOTE:** The **Start** icon  in the Charms sidebar and the Start button  on your computer have the same functionality.

Getting more information on Windows 8

Touch the Getting Started With Windows tile on the Start screen to get more information about the features of Windows 8.



Gestures

Your computer has a 10-point multi-touch display.

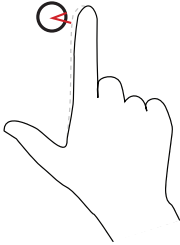
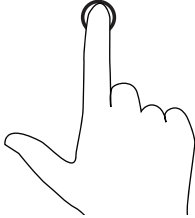
Finger gestures	Allows you to:
<p>Touch</p> <p>Tap gently on the screen with your fingertip.</p> 	<ul style="list-style-type: none">• Select items on the screen including options, entries, images, icons, and so on.• Start applications.• Touch buttons on the screen.• Input text using the on-screen keyboard.
<p>Touch and hold</p> <p>Touch and hold your finger on the screen.</p> 	<ul style="list-style-type: none">• Display detailed information about an item• Open the context menu of an item to perform further actions.

Finger gestures

Allows you to:

Drag

- 1 Touch and hold your finger on an item on the screen.
- 2 Keeping your finger in contact with the screen, move your fingertip to the desired location.
- 3 Take your finger off the screen to drop the item at the desired location.

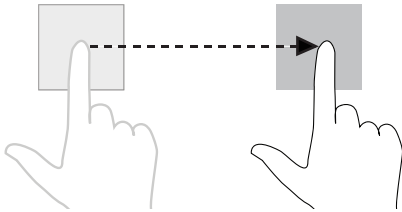

Move items such as images and icons on the screen.

NOTE: Touching and holding for a long time brings up the context menu. If the context menu appears, cancel the action and try again or touch and hold for a shorter duration to be able to drag.

Swipe or slide

Move your finger in a vertical or horizontal direction on the screen.

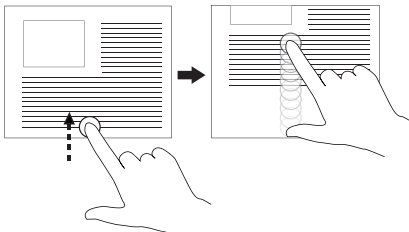

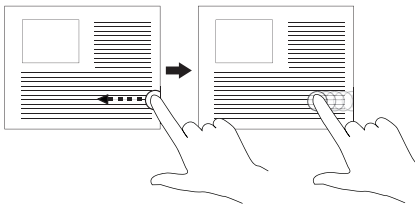

- Scroll through the Start screen, web pages, lists, entries, photos, contacts, and so on.
- Close an app. (Swipe the app to the bottom of the display.)

Swipe left



Swiping-in from the right edge of the display reveals the Charms sidebar. Charms provide access to the system commands, such as Search, Share, Start, Devices, and Settings options.

If your computer is running an application or performing actions, pressing the **Start** icon  takes you back to the Start screen. If you are at the Start screen, pressing the **Start** icon  takes you to the most recently used application or most recently viewed screen.

Finger gestures

Allows you to:

Swipe right

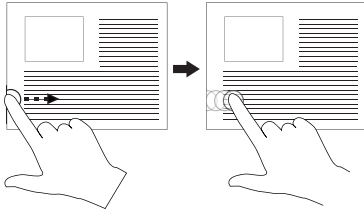

- Swiping-in quickly from the left edge of the display switches the currently running applications.
- Swiping slowly from the left edge to the right edge of the display reveals thumbnails of open applications.
- Swiping-in and out on the left edge of the display brings up a list of the most recently used applications.

Swipe up/down

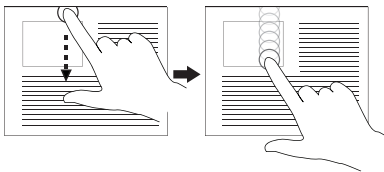

- Swiping-in from the bottom or top edge of the display reveals the **All apps** icon . Touch **All apps** to show an alphabetical list of all applications installed on your computer.
- Swiping-in from the top edge of the application and dragging the application window to the bottom of the screen closes the application.

Zoom out

Touch the display with two fingers and then move the fingers closer.

Reduce the zoom level of an image or web page.

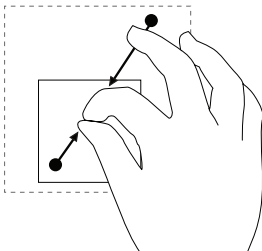

Finger gestures**Allows you to:**

Zoom in

Touch the display with two fingers and then move the fingers apart.

Increase the zoom level of an image or web page.

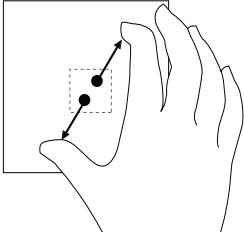

Rotate

Touch the display with two or more fingers and then move the fingers in a clockwise or counter-clockwise arc.

Rotate an object by 90 degrees.

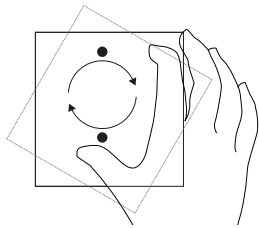

For more information on using Windows 8 Start screen, see <http://support.dell.com/windows8> and <http://windows.microsoft.com/en-US/windows-8/get-started> as well as touching the Dell Getting Started with Windows application (on the Metro screen).

Using the Keyboard and Mouse

If you purchased a wireless keyboard and mouse with your computer, they will be already paired. To use the keyboard and mouse, make sure both devices have batteries installed and are powered on.

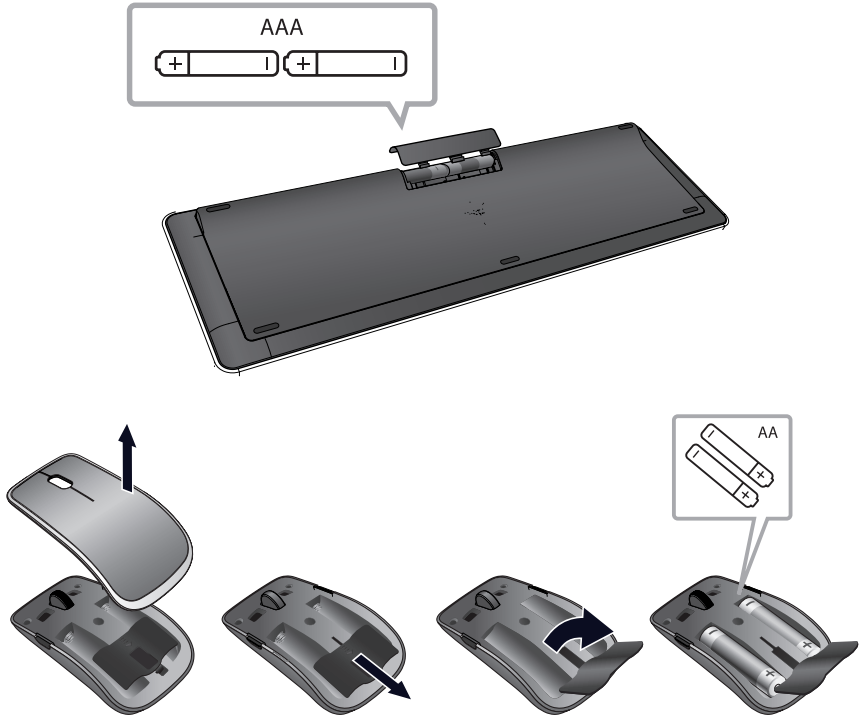

Pairing the wireless keyboard and mouse

If the keyboard and mouse do not work automatically you may need to add them manually:

- 1 Swipe from the right edge of the display to access Charms.
- 2 Touch **Settings**  → **Change PC Settings** → **Devices** → **Add a device**, to manually add a keyboard and mouse.

 **NOTE:** If the keyboard or mouse pairing has been lost for some reason, use these steps to pair them again.

 **NOTE:** The wireless keyboard and mouse may ship with a USB dongle. You do not need to install the dongle to use the wireless keyboard and mouse on this computer.

Using Headphones/Microphones

Your computer has a headphone/microphone combo port that supports a headphone, a microphone, or a combo device to listen to music, record audio, or make voice calls.

WARNING: Listening to loud music for extended periods of time can lead to hearing loss.

NOTE: It is recommended to keep the volume level low before connecting the headphones to your computer.

- 1 Connect headphones to the audio port.





- 2 Insert the headphones in your ears and adjust the volume level to a comfortable level.

NOTE: The integrated speakers on your computer are muted automatically when you connect an audio device to the audio port.

CAUTION: To prevent damage to the headphones when disconnecting them from your computer, pull the connector and not the cable.

Removing the SD Card

 **CAUTION:** To avoid data loss, ensure all read/write operations to the SD card are complete before removing it from the computer.

- 1 Touch the bottom left corner to enter Desktop mode.
- 2 Touch/click **Safely Remove Hardware**  in the notification area at the bottom-right corner of the screen.

 **NOTE:** If you don't see **Safely Remove Hardware** , touch **Show Hidden Icons** to display all icons in the notification area.



- 3 Touch **Eject SD Memory Card**. A message appears confirming that the SD card can be safely removed.

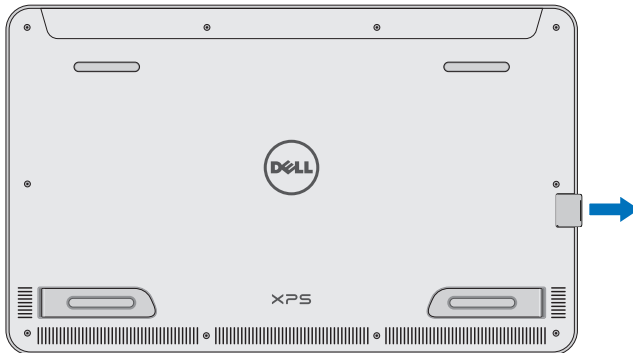

 **NOTE:** If a warning message appears stating the SD card cannot be removed, ensure all data transfers to and from the SD card are complete and try again.

- 4 Push the SD card inwards to release it from the spring loaded SD-card slot.
- 5 Pull the SD card out of the SD-card slot.





Turning Off the Screen

- Using the power button:
Press and release the **Power and Sleep/Wake** button  to turn off the screen.
- Using Charms:
 - 1 Swipe from the right edge of the display to access Charms.
 - 2 Touch **Settings**  → **Power**  → **Sleep** to turn off the screen.

 **NOTE:** If your computer is in a sleep state (computer is on, but screen is off), press the **Power and Sleep/Wake** button  or **Windows** button  once to turn on the screen.

Turning Off Your Computer

- 1 Swipe from the right edge of the display to access Charms.
- 2 Touch **Settings**  → **Power**  → **Shut down** to turn off the computer.

Managing Computer Settings

Refreshing your computer

Refreshing your computer restores Windows to the original factory settings without deleting any of your personal files, installed applications, or personalization settings.

 **CAUTION:** Refreshing your computer removes all third-party applications.

- 1 Swipe from the right edge of the display to access Charms.
- 2 Touch **Settings**  → **Change PC settings** → **General** → **Refresh your PC without affecting your files**.
- 3 Touch **Get started**.
- 4 Read the instructions on the screen then touch **Next**.

Resetting your computer

Resetting your computer returns the system software to original factory settings.

 **CAUTION:** Resetting your computer erases all data from your computer, including your account configuration, music, pictures, files, and so on. Ensure that you back up all the required data before you proceed.

- 1 Swipe from the right edge of the display to access Charms.
- 2 Touch **Settings**  → **Change PC settings** → **General** → **Remove everything and reinstall Windows**.
- 3 Touch **Get started**.
- 4 Read the instructions on the screen then touch **Next**.

Using advanced startup

Use advanced startup if you have problems starting up your computer or if you want to change the computer's startup settings, such as allowing your computer to start up from a USB device or an optical media.

- 1 Swipe from the right edge of the display to access Charms.
- 2 Touch **Settings**  → **Change PC settings** → **General** → **Advanced startup** → **Restart now**.
- 3 Touch the **Troubleshoot** option to configure various startup settings.

Hotkeys

You can access various menus on your computer using the following hotkeys:

Menu	Key combination
Boot menu	Press and release both the volume up and power buttons.
BIOS / System setup menu	Press and release both the volume down and power buttons.
ePSA menu	Press and hold down the volume up and power buttons for 3 seconds then release both buttons.
LCD BIST menu	Press and hold down the volume down and power buttons for 3 seconds then release both buttons.

Menu descriptions:

- **Boot menu** — Allows the user a method to stop the normal start-up of the computer and bring up a special menu to run ePSA or boot from an alternate source other than the normal boot from the system hard drive.
- **BIOS / System setup menu** — A tool that halts the normal boot process and allows the user to enter a BIOS setup mode to review more advanced system information and perform some advanced system settings.

- **ePSA menu** — Dell's Enhanced Pre-Boot System Assessment. ePSA provides valuable configuration and diagnostic information and helps assure correct system operation.
- **LCD BIST menu** — A diagnostic tool which utilizes Built In Self-Test capability to help users trouble shoot a no video scenario by running video test outside the normal path.





NOTE: For more information on the tools available to keep your computer running properly, see dell.com/support.

Synchronizing Your Computer

Using a Microsoft account

You can sync user settings of your computer using a Microsoft account. When you sign in with your Microsoft account on your computer, you can automatically synchronize your settings, including internet browser history, application settings, and personal files and so on, with other Windows 8 computers.

- 1 Swipe from the right edge of the display to access Charms, then click **Settings**  → **Change PC Settings** → **Users** → **Switch to a Microsoft account** to switch a local account to your Microsoft account.
- 2 **Sync your settings** option is added to **PC Settings**.
- 3 Click **Settings**  → **Change PC Settings** → **Sync your settings** to configure synchronization options.

Powered Stand (optional)

Features



Feature	Functionality
1 Docking status light	Turns on when your computer is successfully docked (if the power adapter is attached to the powered stand).
2 Docking connector	Connects the computer to the docking port to provide power to your computer and charge the battery



Feature	Functionality
1 Powered stand hinge	Allows you to adjust the angle of your computer between 10 degrees and 70 degrees.
2 Power-adaptor port	Connect the power adaptor to provide power to the computer, and charge the battery.
3 Adapter cable clip	Holds the adapter cable in place.

Using the Powered Stand

Connect the Power Adapter to the Powered Stand

⚠ CAUTION: Use only the supplied power adapter and power cable. Using unauthorized power adapters or power cables may cause severe damage to your computer and powered stand.

- 1 Connect the power adapter to the power-adapter port on your powered stand.

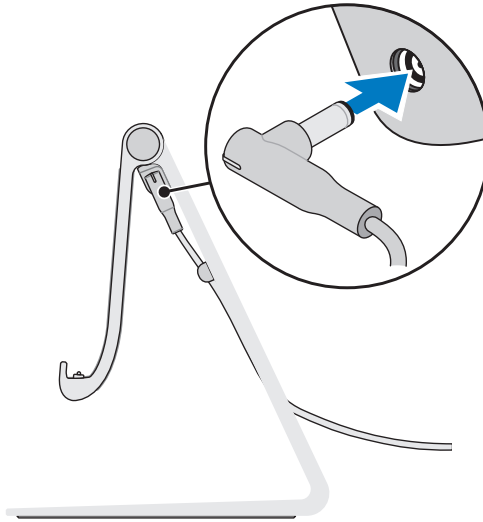

- 2 Connect the power adapter to an electrical outlet.

You can check the powered stand's status from:

- The light located at the front of the powered stand:

LED behavior	Description
Solid white color on	Computer is docked in the powered stand
Off	Computer is not docked in the powered stand, or the power adapter is not connected to the stand.

For more information on checking the battery status, see [battery charge indicator status table](#).



NOTE: If the LED is off and the computer is placed on the powered stand with power, it may not be properly docked. Realign the computer on the powered stand until the LED lights up.

Dock Your Computer on the Powered Stand

- 1 Align the docking port on your computer to the docking connector on the powered stand.



- 2 Place your computer onto the powered stand.

 **NOTE:** The docking status light turns on when your computer is correctly seated on the powered stand and the powered stand is properly connected to a power source.

Undocking Your Computer

Lift the computer from the powered stand.



Cleaning Your Computer

 **CAUTION:** Disconnect all cables from your computer before cleaning it. Clean your computer with a soft cloth dampened with water. Do not use liquid or aerosol cleaners, that may contain flammable substances.

- 1 Turn off your computer. For more information on turning off your computer, see [Turning Off Your Computer](#).
- 2 Moisten a soft, lint-free cloth with either water or a display cleaner, and wipe the surface of the computer until it is clean. Do not allow water from the cloth to seep into the computer ports.

 **NOTE:** Do not spray cleaning solution directly onto the display. Only use products specifically designed for cleaning displays, and follow the instructions that are included with the product.

Troubleshooting

Battery Problems

Problems	Possible causes	Possible solution
Battery does not charge	<ul style="list-style-type: none">• Your computer is not properly plugged into a power source.• You are using an incorrect power adapter/cable.• The power outlet is not be working.• The power adapter/cable is too loosely connected.	<ol style="list-style-type: none">1 Use the supplied power adapter and power cable.2 Unplug the power adapter from the wall and verify that the outlet is functioning.3 Check all cable connections and plug back into the wall, then back into the computer.4 Check all connectors to ensure proper connectivity.5 Verify that the power adapter's white LED is on. If it is not, unplug and re-plug the power adapter and/or try another outlet that is known to work. If the LED still does not turn on, try replacing the power adapter
	The computer temperature is lower than 0 °C or higher than 35 °C.	Charge the battery in an ambient temperature between 0 °C and 35 °C.
	The battery or power adapter is damaged.	Contact technical support or the manufacturer to replace the damaged parts.

System problem

Problems	Possible causes	Possible solution
Computer does not turn on	The battery is completely discharged.	Connect your computer to a power source using the power adapter.
	Your computer could be in an unresponsive or locked state.	Press and hold the power button for 11 seconds to perform a hard shut down, then press the power button to turn the computer back on.
	Your computer may be in shipping mode.	Computers shipped from the factory will be set in shipping mode. To get out of this mode, the user needs to plug in the power adapter and press the power button to turn on the computer. After the initial power up, the computer behaves as normal. This is to avoid the computer from being accidentally turned on during shipping and draining the battery.

<p>Computer is not responding or behaving unexpectedly</p>	<p>Your computer could be in a hung or locked state.</p>	<ol style="list-style-type: none"> 1 Reboot the computer. See Turning Off Your Computer and Turning On Your Computer. 2 Refresh your computer. See Refreshing your computer. 3 Reset your computer. See Resetting your computer. 4 Contact Dell's support service. Go to dell.com/support or dell.com/ContactDell.
<p>Software or feature is not working as expected</p>	<p>The application or feature could be in a hung state.</p>	<p>Software updates may have been downloaded in the background. Restart your computer. Swipe from the right edge of the display to access Charms and touch Settings → Power → Restart to restart the computer.</p>

Touchscreen problem

Problems	Possible causes	Possible solution
<p>Touchscreen responds slowly or improperly</p>	<p>Your computer display may be dirty, or you may need to adjust display settings</p>	<ul style="list-style-type: none"> • Turn off your computer screen to avoid accidental touches, then gently wipe the display with a clean dry cloth. • Adjust display settings in Windows Desktop, Control Panel → Appearance and Personalization → Display.

Network problem

Problems	Possible causes	Possible solution
No wireless connection	Your computer is not able to properly access a wireless signal.	<ol style="list-style-type: none">1 Check if the wireless radio is on. See Enabling/Disabling Wi-Fi.2 Move closer to the wireless access point.3 Reset the wireless router if using a private network.4 Open the browser to view the landing page if using a public network, and follow the instructions given by the public network.5 Try another wireless connection.
Slow Internet connections	The signal strength is not strong enough.	<ol style="list-style-type: none">1 Move your computer to a different location for better signal reception.2 Contact your Internet Service Provider.

Locating Your Service Tag and Express Service Code

You need your computer's Service Tag/Express Service Code when you contact Dell regarding your computer. The Express Service Code helps the automated telephone support system redirect your call to the appropriate support department.

The Service Tag and Express Service Code for your computer are located on a label at the back of your computer.

⚠ CAUTION: Lay your computer face down before you look for Service Tag and Express Service Code.

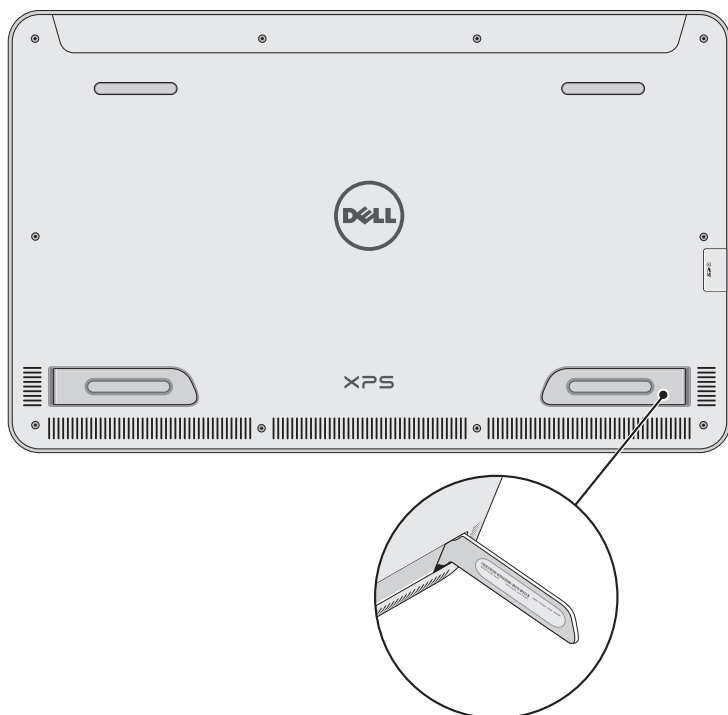

Specifications

Physical dimensions

Height	283.70 mm (11.17 inches)
Width	463.60 mm (18.25 inches)
Depth	17.70 mm (0.70 inch)
Weight	2.20 kg (4.85 lb)

Hardware

Processor	3rd Generation Intel Core i3/i5/i7 ULT Pentium Dual Core
Chipset	Intel Panther Point HM77
Graphics	Intel HD 4000 for Core I processors Intel HD for Pentium Dual Core processors
Internal Memory (RAM)	4 GB or 8 GB DDR3L 1600 MHz
Internal Storage	2.5 inch HDD (SATA3) or SSD (mSATA)
Speaker Power	2 watts
Camera	HD 720 p (1280 x 720)

Touchscreen display

Type	18.4" Full HD with multi-point capacitive touch
Maximum resolution	1920 x 1080
Aspect ratio	16:9
Brightness	350 nits
Viewing angle	89 degrees
Contrast ratio	1000:1
Color depth	262.144 bits

Ports and connectors

Audio	1 3.5mm audio jack/port
SD card	1 SD card slot
Dock	1 docking port
USB	2 USB 3.0 ports 1 internal USB 2.0 port for wireless keyboard and mouse receiver

Power Adapter

Input voltage	90 -240 VAC
Input current (maximum)	1.6 A
Input frequency	50-60 Hz
Output power	65 W
Output current	3.34 A (maximum)
Rated output voltage	19.5 VDC
Temperature range:	
Operating	0 °C to 40 °C (32 °F to 104 °F)
Storage	-40 °C to 70 °C (-40 °F to 158 °F)

Environmental requirements

Temperature range:

Operating	0 °C to 35 °C (32 °F to 95 °F)
Non-Operating	-40 °C to 65 °C (-40 °F to 149 °F)

Relative humidity (maximum):

Operating	10% to 90% (noncondensing)
Non-Operating	5% to 95% (noncondensing)

Maximum Vibration (measured using a random vibration spectrum that simulates user environment):

Operating	0.66 GRMS
Non-Operating	1.30 GRMS

Maximum Shock

Operating	140 G
Non-Operating	163 G

Altitude (maximum, unpressurized):

Operating	-15.2 m to 3048 m (-50 ft to 10,000 ft)
Non-Operating	-15.2 m to 10,668 m (-50 ft to 35,000 ft)
